

Dominator 2-Element Vertical Beam Antenna by KJ6ER

Introduction

The **Dominator Beam** is a *portable, resonant 2-element halfwave vertical beam* antenna covering the 17M-10M bands (*one-band-at-a-time*) utilizing two 25' whips: one end-fed by a 49/56:1 transformer on a tripod, and the other as a parasitic director on a supporting PVC structure. If two 17' whips are used instead, the antenna covers the 12M-10M bands. The driven element is my **Dominator Halfwave Vertical** (please see the [PDF for detailed information](#) on how to build that antenna).

The add-on PVC structure to support a second whip transforms the Dominator into a portable 2-element vertical beam. It requires no radials or a tuner but *does* require a linked counterpoise off the transformer. This is a great beam antenna – easy to pack, fast to deploy, very effective and highly efficient!

I have computer modeled the antenna in 4NEC2 and calculated optimal driven whip and counterpoise lengths for each of the four bands. The parasitic director element is always **6% shorter** than the driven element on each band. The spacing between the two elements for each of the four bands is provided by the [W7MEM 2-Element Yagi Array calculator](#). In the field, I typically measure **<1.10:1** SWR on all four bands, 17M-10M. I have found through my modeling, this halfwave vertical beam antenna has **forward gain** up to **4.0 dBi**, a **front-to-back ratio** up to **9.0 dB**, and very **high structural efficiency** up to **99.5%**.



Why a Parasitic Director Element

When I was designing this portable 2-element vertical beam, I had the option of either implementing a parasitic reflector *behind* the driven element, or a parasitic director *in front* of it. While both configurations work, I elected to deploy the parasitic director instead of the reflector.

There are **three key advantages** of using a parasitic director over a parasitic reflector in a 2-element beam:

- 1) Slightly higher *forward gain*.
- 2) Better *front-to-back* ratio.
- 3) Most importantly, the *element spacing* required for a parasitic director is much *less* than a reflector offering a *shorter* boom length and more portability.

The parasitic director is a second 25' or 17' whip attached to a 3/8"-24 coupling nut at the end of a horizontal PVC tube. A slightly smaller diameter PVC tube slides within it (like a *trombone*) to easily accommodate the four different band spacings between the elements. One end of the horizontal telescoping PVC tube rests securely on the tripod base, while the other end rests on vertical PVC tube base under the parasitic director.



2 PVC tubes slide like a *trombone* to allow variable spacing between the elements

Dominator 2-Element Vertical Beam Antenna by KJ6ER

Why a Parasitic Director Element *(continued)*

When a parasitic director is added to the Dominator Halfwave Vertical Antenna, the antenna generates directionality with forward gain and a front-to-back ratio with the same high efficiency.

On the **10M** band, the forward gain is **+3.92 dBi** at **16°** off the horizon (**2°** lower than the *omnidirectional* Dominator). On the **backside at 16°**, the gain is **-4.62 dBi** providing a front-to-back ratio of **8.54 dB**.

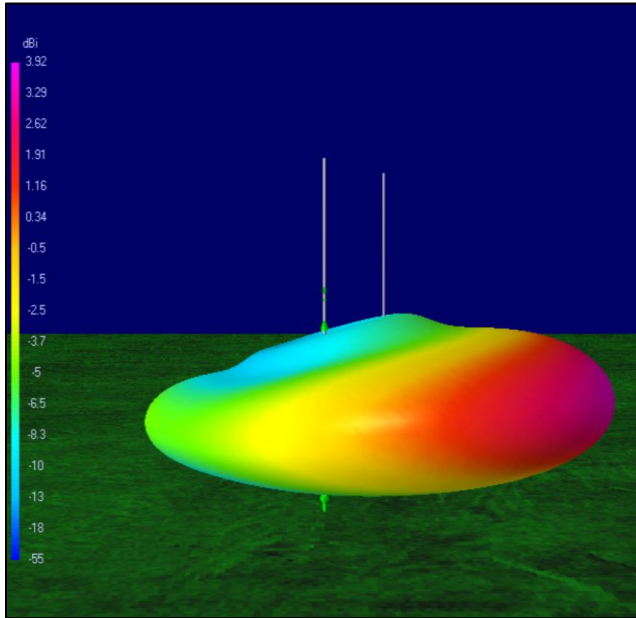

The strong purple and red edges of the Dominator Beam radiation pattern highlight the strongest forward gain of the antenna at 16 degrees on 10M.

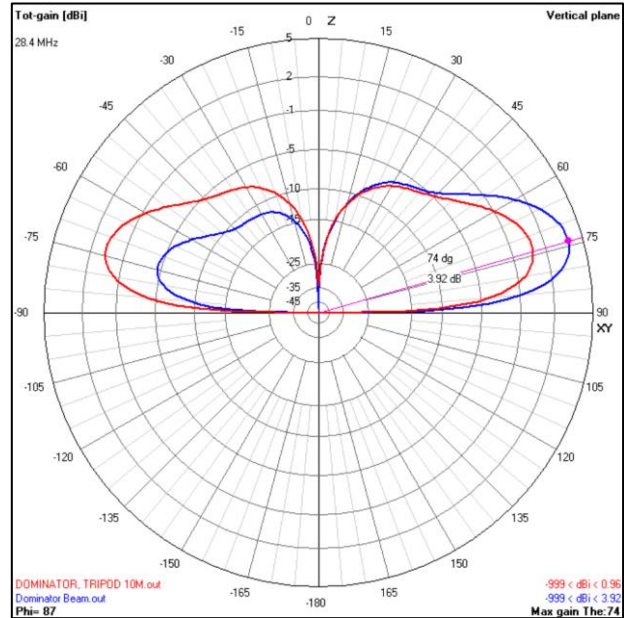

Note the Dominator Beam generates **+3.92 dBi** forward gain at **16 degrees** off the horizon versus the *omnidirectional* Dominator with **+0.96 dBi**.

Antenna System Parts List with Prices and Links (as of December 2024)

See the parts list for my [Dominator Halfwave Vertical Antenna](#) to build the driven element structure on a tripod. That requires one 25' or 17' telescoping whip. The additional parts to build the add-on PVC structure for a second 25' or 17' whip as the parasitic director include: (*substitute as you wish*)

- Chameleon™ CHA SS25 25' telescoping whip (\$100) – chameleonantenna.com/shop-here/ols/products/cha-ss25, or alternatively for 12M-10M bands only: Chameleon™ CHA SS17 17' telescoping whip (\$70) – chameleonantenna.com/shop-here/ols/products/cha-ss17

PVC Support Structure (primary parts only):

- U-Bolt Antenna Mount Clamp (\$7, pkg 2) – amazon.com/dp/B09BVGQS58
- 1-1/8" 3/8-24 Coupling Nut, Fine Thread (\$12, pkg 5) – amazon.com/dp/B00L1L69UM
- 3/8" x 1-1/4" Fender Washers (\$18, pkg 100) – amazon.com/dp/B000BDB7IU
- 1" PVC Furniture Grade Flat End Caps (\$8, pkg 10) – amazon.com/dp/B0BQ2XHYPN
- 40" Furniture Grade 1-1/4" PVC tube (\$29, pkg 3) – amazon.com/dp/B085B52153
- 40" Furniture Grade 1" PVC tube (\$27, pkg 3) – amazon.com/dp/B085B4PMJ3
- 1" PVC Side Outlet Elbow (\$12, pkg 4) – amazon.com/dp/B00MNIZM7I
- 1-1/4" to 1" PVC Reducing Elbow (\$3) – lowes.com/pd/Charlotte-Pipe-1-1-4-IN-X-1-IN-90-DEG-ELBOW/5012489249

Dominator 2-Element Vertical Beam Antenna by KJ6ER

Building the PVC Support Structure

This is how I designed and built the PVC support structure for the parasitic director. While this design works very well for me in the field, you may want to modify it for your deployment based upon your design preferences or what parts you have on hand. Hopefully, this design will inspire you to create your own.

The PVC structure is made up of **3 sections** so that the entire assembly will **easily come apart** and **lay flat for storage and transport**. All PVC joints are glued except where noted at the *reducing elbow* on the top of the vertical support and the *side outlet elbow* at the bottom of the vertical support.

PVC Parts List

- 3x 1" PVC Tube
- 3x 1" PVC End Caps
- 1x 1-1/4" PVC Tube
- 1x 1" PVC Coupler
- 1x 1" PVC Elbow Side Outlet
- 1x 1-1/4" to 1" PVC Reducing Elbow

Hardware Parts List

- 1x U-Bolt Antenna Mount Clamp
- 1x 1/2" Diameter Heat Shrink Tubing
- 2x 1-1/4" Fender Washers
- 1x 3/8"-24 Coupling Nut
- Miscellaneous bolts, washers, nuts

Tripod Coupling and Trombone PVC Structure

(not to scale)

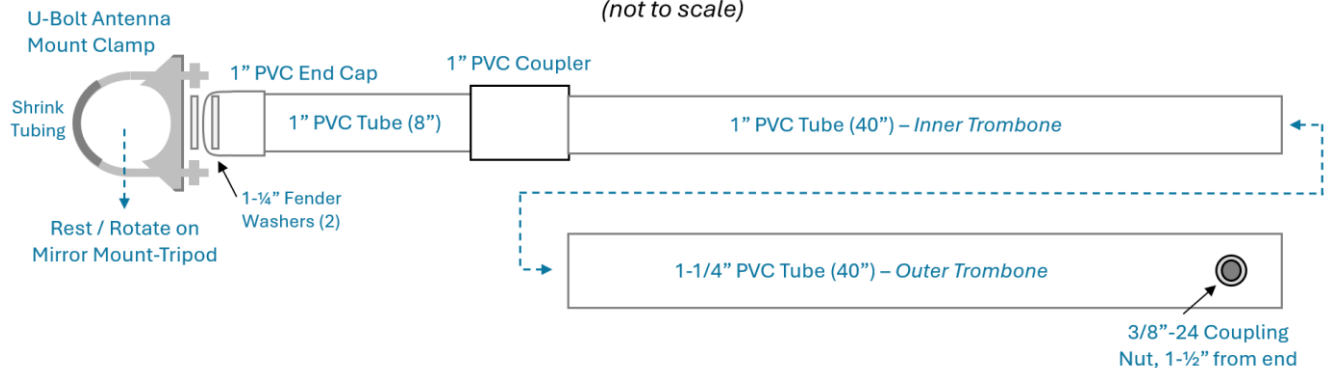

The first section is the **horizontal structure**, or what I call the **trombone** – one PVC tube *sliding* within the other to facilitate band spacing for 10M, 12M, 15M and 17M. A U-bolt antenna mount at the end is used to *rest* on the mirror mount-tripod, as well as make it easy to *manually rotate* the 2-element beam in the desired direction. Once completed, I recommend you mark the inner trombone tube in four places, one for each band, measuring between the driven element mount clamp and the director coupling nut. This will make it easy for you to change bands in the field. The mark is at the *intersection* of the two tubes.

Marking the Inner Trombone for Band Spacing

(not to scale)

Measure the distance between the **Antenna Mount** and the 3/8"-24 **Coupling Nut** for the director.

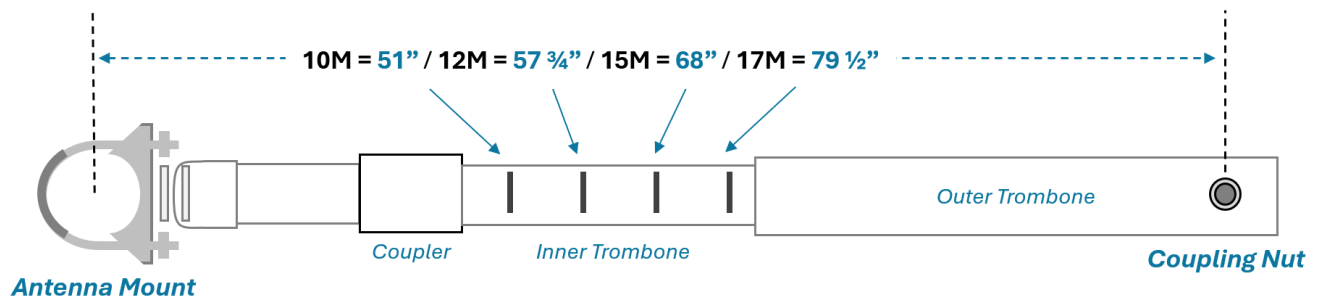

Dominator 2-Element Vertical Beam Antenna by KJ6ER

Building the PVC Support Structure (*continued*)

The top horizontal PVC trombone section rests on the mirror mount-tripod and extends to the parasitic director coupling nut on the outer trombone 1-1/4" PVC section. The coupling nut should be drilled and attached approximately 1-1/2" from the end of that tube to accommodate spacing for attachment to the reducing elbow. Use flat washers and a lock washer under the nut.

The 1-1/4" PVC outer trombone section *pressure fits* into a 1-1/4" to 1" PVC reducing elbow. It should *not* be glued so that the trombone section can be gently twisted to allow parallel alignment of the two elements in the field. You can easily line them up by eye.

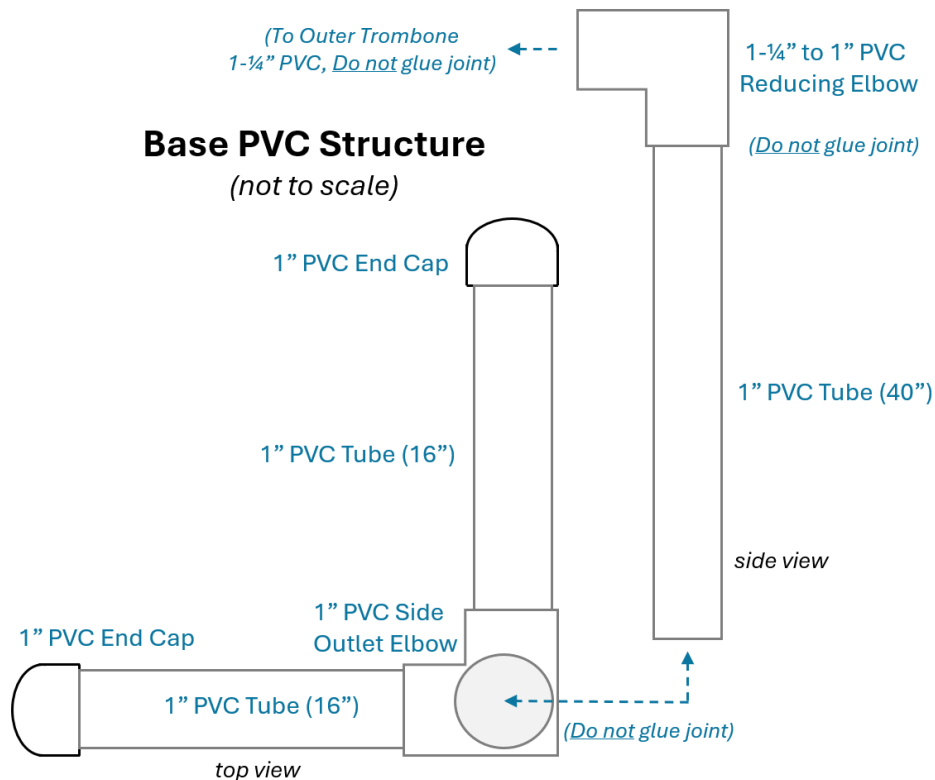

The other side of the PVC reducing elbow *pressure fits* into a 1" PVC tube (40") which becomes the **vertical support section** for the parasitic director. Like the horizontal trombone section, the vertical tube can be twisted gently to align the two right-angle base elements to *face* the tripod at their open center. Placing them *inward* towards the tripod provides good physical stability.

The **ground support base section** includes the two right angle 1" PVC tubes (16") with end caps. These two 16" tubes (32" cut in half) are *left over* after the 8" section is cut for the horizontal section. The vertical 1" PVC tube *pressure fits* into the 1" PVC side outlet elbow that connects the two right angle tubes together. The vertical tube should *not* be glued into the side outlet elbow so it can be easily removed from the base for *flat storage and transport*.

In summary, there are **3 sections** that can be assembled and easily pulled apart for transport and storage: 1) **horizontal trombone**, 2) **vertical support**, and 3) **ground support base**.

Dominator 2-Element Vertical Beam Antenna by KJ6ER

Construction Details for the U-Bolt Antenna Mount and End Cap

The U-bolt antenna mount is used at the end of the horizontal trombone section to allow the section to rest securely on the tripod at the base of the 25' driven telescoping whip. The U-shape also makes it easy to manually rotate the parasitic whip in the desired radiation direction.

The assembly requires the use of all the hardware that came with the U-bolt antenna mount (package of 2). You can save the spare U-bolt and plate for a future project (less the hardware). You will need all the hardware so that the U-bolt can be secured with the hardware on *both sides* of the mount plate. I recommend you only leave about a 1/4" of the U-bolt threads extending at the bottom as shown in the bottom right photo below. I also added 1/2" diameter shrinking on the U-bolt to help it rest more securely on the tripod mirror mount.

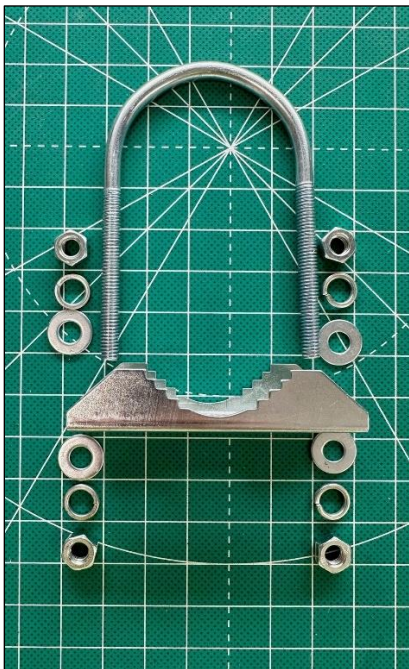

U-bolt antenna clamp mount comes in a package of 2. Use all the hardware from both to create one that will rest on the tripod.

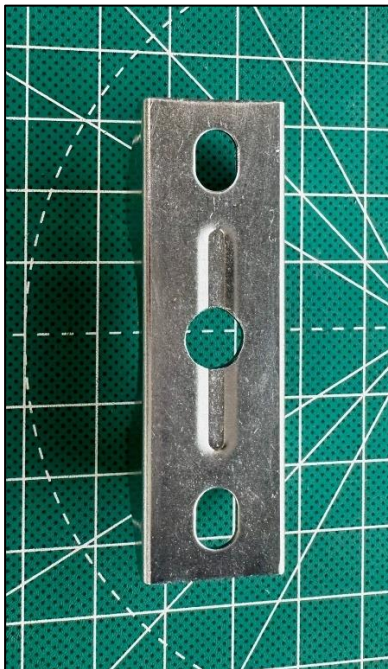

Drill a 3/8" hole in the center of the antenna mount plate so that it can be securely attached to the 1" PVC end cap.



Drill a 3/8" hole in the center of end cap. Use 3/8"-24 hardware including 2 fender washers on *both sides* of the PVC end cap.



(Top view) Attach antenna mount plate to the 1" PVC end cap.

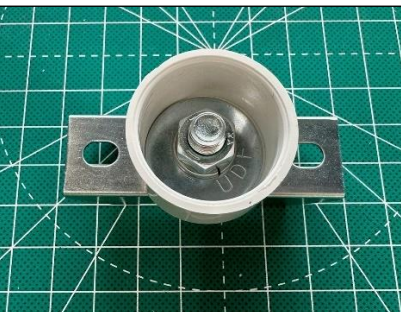

(Bottom view) Fender washers fit perfectly on *both sides* of the cap.



Before attachment, add 1/2" diam. shrink tubing on the U-bolt.

Dominator 2-Element Vertical Beam Antenna by KJ6ER

Construction Details for the Horizontal Trombone Section and Base Legs

If you purchase both the 1 ¼" and 1" furniture grade PVC tube packages (40") recommended in the parts list, each comes in a package of 3 tubes. Only *one* of the 1 ¼" tubes is required for use as the *outer* trombone, the other two can be saved for another project.

However, all *three* of the 1" furniture grade PVC tubes (40") will be used: one for the *inner* trombone, one for the vertical support to the ground base and the third will be cut into *three pieces*: an 8" tube for the end cap assembly and the other two as 16" legs in the ground base.

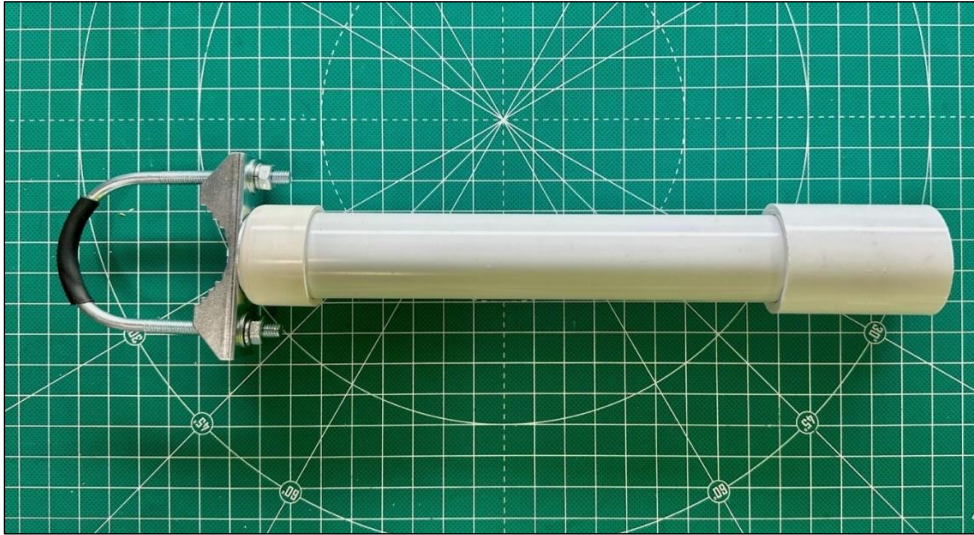

Cut an 8" section of a 1" PVC tube and *glue* it to the end cap assembly. At the other end, *glue* a 1" PVC coupler. At the *other side* of the coupler, glue another 1" PVC tube (40") to create the *inner* trombone.

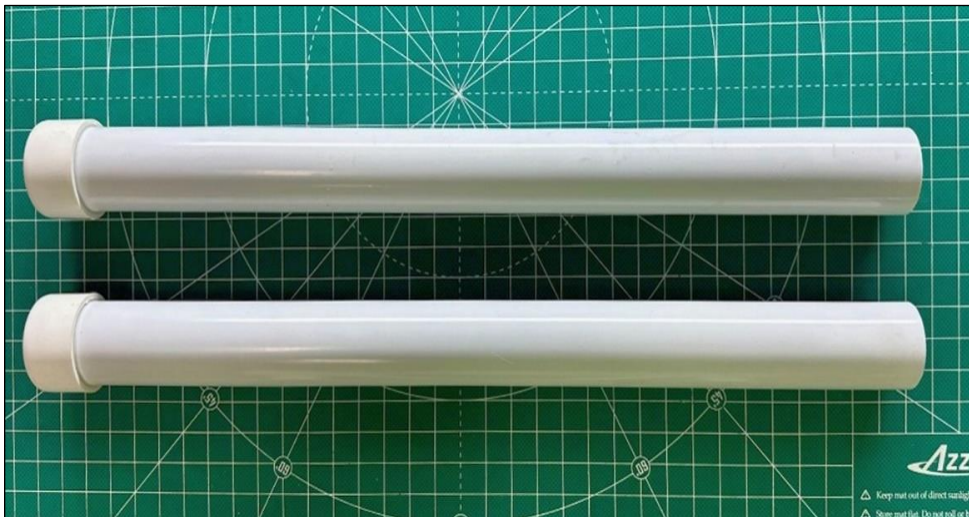

Cut the remaining 32" of the 1" PVC tube in half to create *two* 16" sections. *Glue* a 1" end cap on each tube. These pieces become the legs for the ground support base which are *glued* into the 1" side outlet elbow.

Dominator 2-Element Vertical Beam Antenna by KJ6ER

Computer Model Specifications and Field Measurements

A 4NEC2 computer model was created to determine optimal lengths for the driven element and the parasitic director for each of the four bands. The model also confirmed the *band element spacing* provided by the [W7MEM 2-Element Yagi Array calculator](#). The computed results were excellent, *averaging* **SWR = 1.00:1**, **Ref. Coef. = -58 dB**, **Gain = 3.8 dBi**, **FtB = 8.4 dB** and **Efficiency = 99%** across four bands.

| Band | Target Freq. (MHz) | Computer Model Specifications | | | | | | | | |
|------|--------------------|-------------------------------|---------------|------------|-----------------|-----------------------|----------|----------|------------|---------------|
| | | SWR | Ref Coef (dB) | Gain (dBi) | Rad Angle (deg) | -3 dB Beamwidth (deg) | | FtB (dB) | Efficiency | Impedance |
| 17M | 18.140 | 1.00 | -68.8 | 3.23 | 17 | 25 | 7° - 32° | 8.28 | 99.4% | 2442 - j 0.45 |
| 15M | 21.350 | 1.01 | -50.1 | 3.47 | 17 | 24 | 7° - 31° | 8.31 | 98.4% | 2465 + j 3.32 |
| 12M | 24.940 | 1.00 | -58.1 | 3.71 | 16 | 24 | 7° - 31° | 8.50 | 98.5% | 2455 + j 2.95 |
| 10M | 28.400 | 1.00 | -54.0 | 3.92 | 16 | 24 | 7° - 31° | 8.54 | 99.5% | 2460 - j 1.24 |
| | | 1.00 | -57.8 | 3.58 | 17 | 24 | | 8.41 | 99.0% | Z = R + j X |

When in the field, *real world* ground conditions and near-field surroundings always impact overall antenna performance. However, the field measurements were equally excellent. Note in the total driven whip lengths shown below that it *also includes a 1' pigtail* off the transformer which is *added* to the driven whip length. Use these lengths as a guide and good place to *begin tuning* the antenna system in the field.

| | | In-Field Measurements | | | | | | |
|------|--------------------|-----------------------|--------|---------------|--------------------|--------|--------------|--------|
| Band | Target Freq. (MHz) | Driven Element | | Spacing | Parasitic Director | | Counterpoise | |
| | | Whip Length | Inches | Between Whips | Whip (6% Less) | Inches | CP Length | Inches |
| 17M | 18.140 | 23' 2" | 278 | 79.5" | 21' 9" | 261 | 17' 2" | 206 |
| 15M | 21.350 | 19' 0" | 228 | 68" | 17' 10" | 214 | 14' 7" | 175 |
| 12M | 24.940 | 16' 7" | 199 | 57.75" | 15' 7" | 187 | 12' 6" | 150 |
| 10M | 28.400 | 14' 9" | 177 | 51" | 13' 10" | 166 | 11' 0" | 132 |

| | | 25' Chameleon Whips (2-Element Vertical Beam) | | | | | | | |
|------|--------------------|---|-------------|--------------------|--------------|---------------|--------------------|-------------|-------------------|
| Band | Target Freq. (MHz) | Driven Element | | | | Spacing | Parasitic Director | | |
| | | Whip Pigtail | Whip Length | Whip Configuration | Total Length | Between Whips | Whip Configuration | Whip Length | Whip Length Delta |
| 17M | 18.140 | 1' 0" | 22' 2" | 11 sec + 11" | 23' 2" | 79.5" | 11 sec + 6" | 21' 9" | -5" |
| 15M | 21.350 | 1' 0" | 18' 0" | 9 sec + 9" | 19' 0" | 68" | 9 sec + 1" | 17' 10" | -8" |
| 12M | 24.940 | 1' 0" | 15' 7" | 7 sec + 16" | 16' 7" | 57.75" | 7 sec + 16" | 15' 7" | +0" |
| 10M | 28.400 | 1' 0" | 13' 9" | 6 sec + 15" | 14' 9" | 51" | 6 sec + 14" | 13' 10" | -1" |

If you use **two 17' telescoping whips** instead of the 25' whips, you will be able to cover the 12M-10M bands only. As noted in the table above, both of those bands do not require whips over 17' long.

Dominator 2-Element Vertical Beam Antenna by KJ6ER

Finetuning the Beam in the Field

Using an **antenna analyzer**, I recommend adjusting the **driven element** first *without* the parasitic director in place and tune it to resonance with the linked counterpoise laid out on the ground. Make sure you extend the *PVC trombone* to the designated band spacing.

Once **SWR is optimized**, attach the **parasitic director** to the PVC structure keeping its length about 6" *shorter* to *start* and measure the SWR again. When you tune the 2-element beam to the band, you may find that you may have to adjust one whip a little and then the other. It is a *brief* iterative process but is not as difficult as it seems at first.

As you would expect, a *longer driven element* *lowers* the resonance, and a *shorter driven element* *raises* the resonance. Interestingly, I discovered a longer *director element* *slightly raises* the resonance, while a shorter *director element* *lowers* it a little. The first time you deploy the beam, you will have to experiment to determine the best combination of element lengths in your particular location. But once you have done this a couple times, it will be relatively easy to remember generally where to extend the whips and tune the antenna to the band very quickly.



Field SWR Measurements of the Antenna for each Band. The broad bandwidth of the Dominator Beam antenna allows you to operate across every band without having to adjust the telescoping whips. At resonance, the SWR is **<1.10:1** on all bands and **<1.20:1** at band edges.

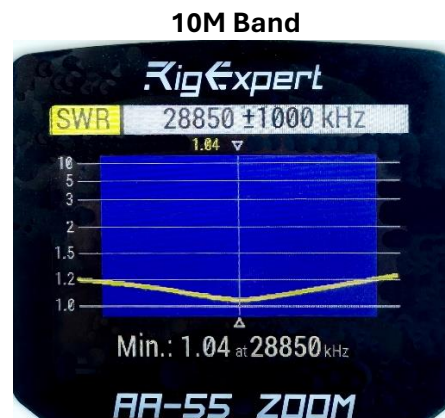
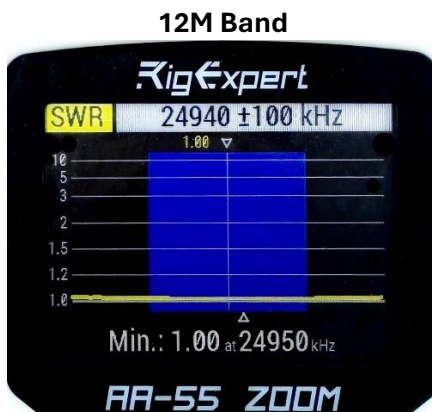
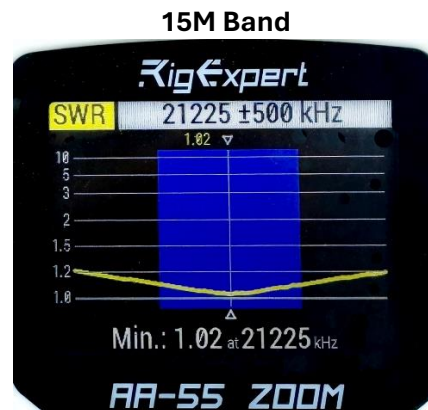
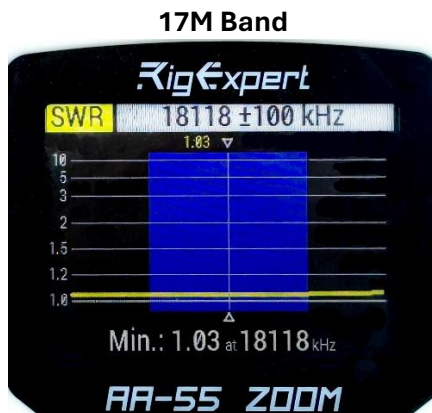

Dominator 2-Element Vertical Beam Antenna by KJ6ER

Transporting the Dominator Beam

The [Dominator Halfwave Vertical Antenna](#) (as the *driven* element) is a very portable antenna system. It is composed of a tripod, 49/56:1 transformer, 25' telescoping whip and linked counterpoise which all fit neatly in a [36" photography bag](#). Along with the antenna system, I include a RigExpert™ Stick in the bag for fast and easy field tuning.

This is not a *typical* multiband EFHW antenna because it is halfwave resonant on *each* of the bands *one-band-at-a-time* by adjusting the telescoping whip and linked counterpoise to resonance. As a *single element* vertical antenna, it provides strong low angle, omnidirectional gain averaging **+0.56 dBi** across four bands, 17M-10M.

When coupled with an add-on *parasitic director* in *front* of this driven element, the **Dominator 2-Element Vertical Beam** provides additional forward gain and front-to-back ratio, along with a slightly lower peak radiation angle of **16°** for great DX potential and a very narrow -3 dB beamwidth of **24°** across four bands, 17M-10M.

In the field, the second 25' or 17' whip as the *parasitic director* also fits within the same 36" bag along with the rest of the *driven element*. The add-on PVC structure supporting the *director* has been designed and constructed to break down into **3 separate sections** that *lay flat for easy transport and storage*. Remember, do *not* glue the joints for the *reducing* or the *side outlet elbows* on the vertical support tube.

Section 1 is the *horizontal trombone* that rests on top of the tripod and supports the director. **Section 2** is the *vertical support* attached at the end of the trombone, and **Section 3** is the *ground support base* attached at the bottom of the vertical support.



When in the field, set up the *tripod* first, then assemble the *PVC structure* to rest on it, and finally attach the *driven element*. Once tuned, attach the *parasitic director* and then tune *both whips together*. Now you have the globe at your portable radio fingertips!

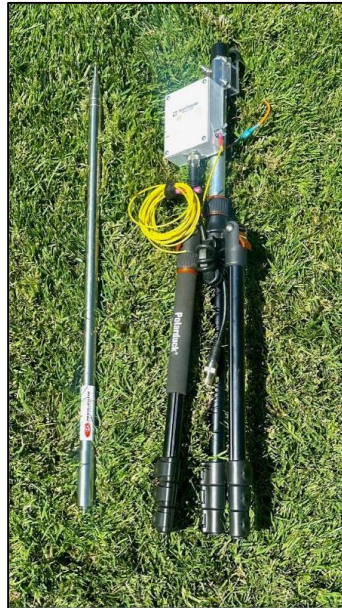

The Dominator Halfwave Vertical Antenna includes a 25' telescoping whip and a 49/56:1 transformer already mounted on a tripod.



The entire antenna system is very compact and can easily be carried in a 36" long bag along with all the required accessories.

Dominator 2-Element Vertical Beam Antenna by KJ6ER

Final Comments

The Dominator Beam is a highly effective *portable* 2-element vertical beam antenna, and I strongly encourage you to try it in the field. It is resonant on *each* of the four bands, *one-band-at-a-time*, by adjusting both *telescoping whips*, the element spacing via the *trombone* and the *linked counterpoise*. Once you have used the beam a few times in the field, you will easily remember the optimal element lengths for each band. In addition to its high performance, it is extremely easy and lightweight to pack, and fast to deploy in about *4 minutes*.

I expect that purchasing two Chameleon™ 25' whips at \$100 each could be *cost-prohibitive* for some hams. While I consider these the best telescoping whips on the market, I know there are many extra-long imported whips that are less expensive (albeit less quality). Alternatively, the Dominator Beam can be also used with two Chameleon™ 17' whips (\$70 each) or *equivalent* to cover the 12M-10M bands at a lower cost. During the strong sunspot cycle peak we are currently experiencing, this 2-element beam may be perfect for those who want low angle DX coverage on the upper bands. I am certainly having a lot of fun with it during POTA!

Ultimately, my intent to design and construct this *portable* 2-element vertical beam was to **prove that it could be done and successfully utilized** for a POTA activation. I have now deployed the Dominator Beam at dozens of activations to date and the results have been amazing! Not only did I receive strong 57-59 signal reports along the eastern seaboard from the west coast, but I picked up more DX stations in Asia-Pacific, South America and Europe than I have done before (when conditions permit).

The [PERformer](#), [Challenger](#), [Dominator](#) and this *new* Dominator 2-Element Vertical Beam antennas are all highly efficient, effective and very portable. They are ideal for **POTA**, as well as **emergency communications** and **HOA deployments**. Have fun building and deploying them in the field!

One of my favorite parts of HAM radio is experimentation – especially with portable antennas. Give it a try and have some fun!

Please let me know if you have any questions, I'd be happy to help, 73! 😊

Greg Mihran, KJ6ER
Campbell, California
www.qrz.com/db/KJ6ER
gmihran@me.com
(650) 714-7577



Dominator Vertical Beam at a POTA activation in San Jose, US-3473.

